

# Formen von Anhängerfedern

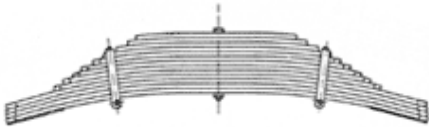

Anh\_10

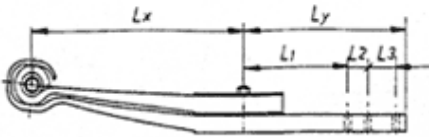

Anh\_12a

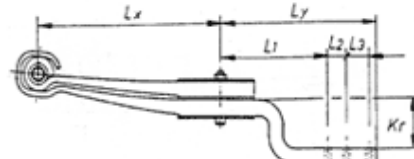

Anh\_12c

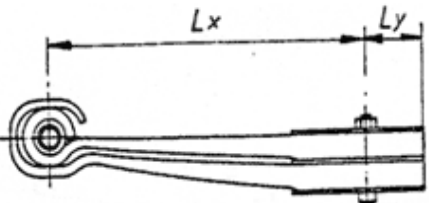

Anh\_12d

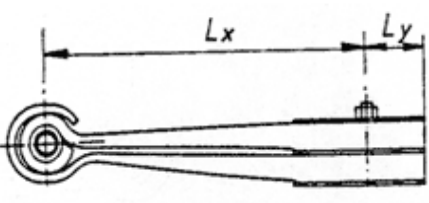

Anh\_12d

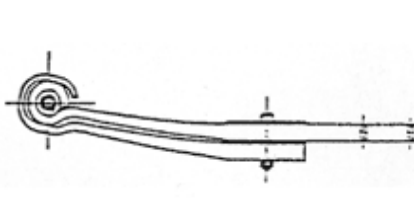

Anh\_12d

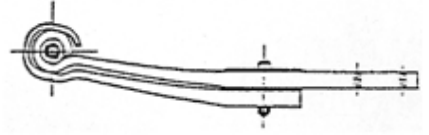

Anh\_12d2

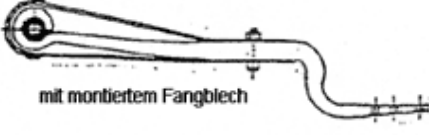

mit montiertem Fangblech

Anh\_12f

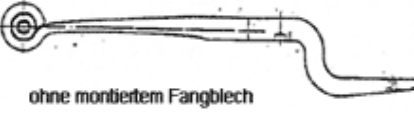

ohne montiertem Fangblech

Anh\_12f

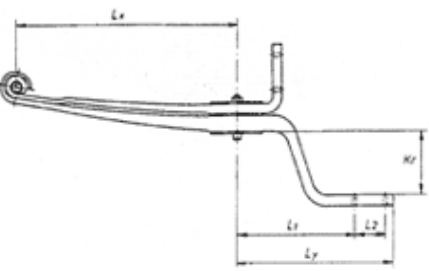

Anh\_13



Anh\_14

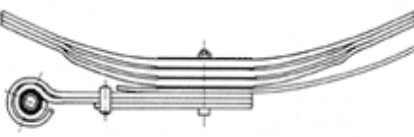

Anh\_18

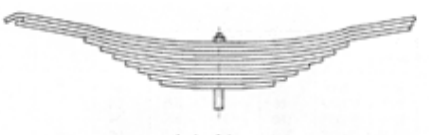

Anh\_21



Anh\_23

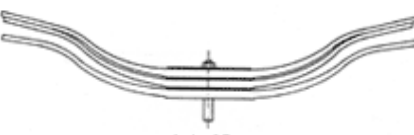

Anh\_25

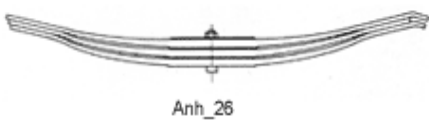

Anh\_26



Anh\_27

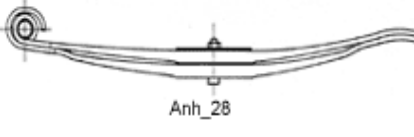

Anh\_28



Anh\_29

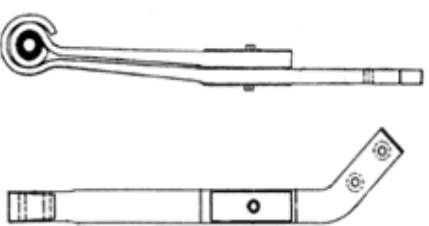

Anh\_30

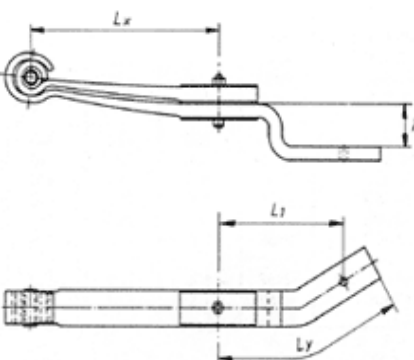

Anh\_32

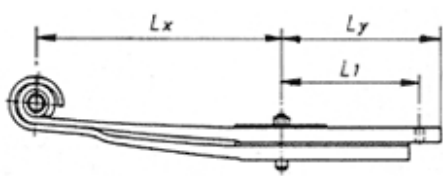

Anh\_33\_1

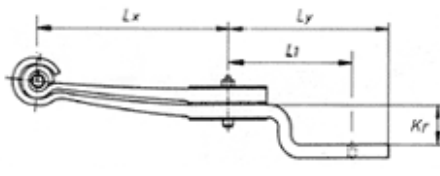

Anh\_33\_5

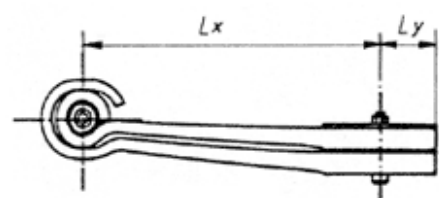

Anh\_36\_1

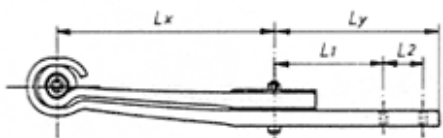

Anh\_36\_5

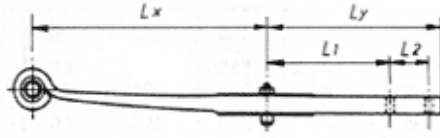

Anh\_36\_6

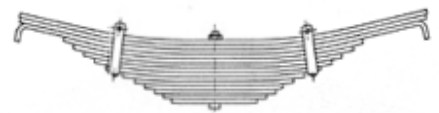

Anh\_40

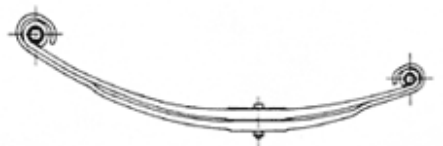

Anh\_42

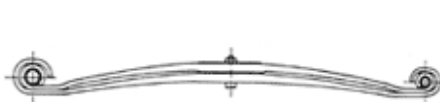

Anh\_43a

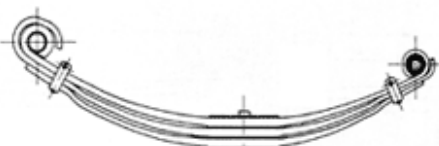

Anh\_43b

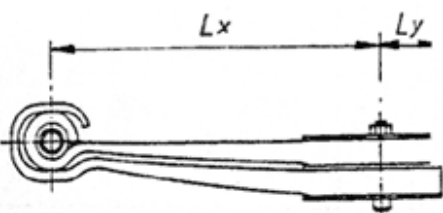

Anh\_44a2

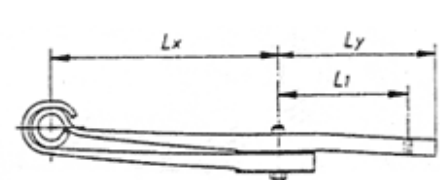

Anh\_44a6

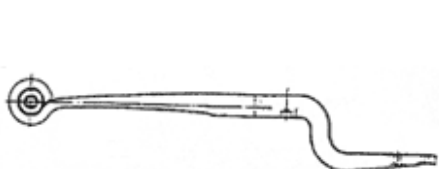

Anh\_44a7

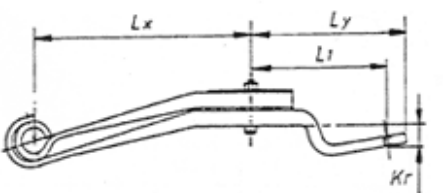

Anh\_44a8



Anh\_47a

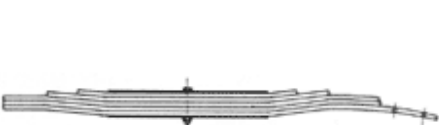

Anh\_47b



Anh\_4b



Anh\_5

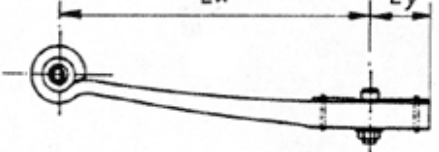

Anh\_50\_2

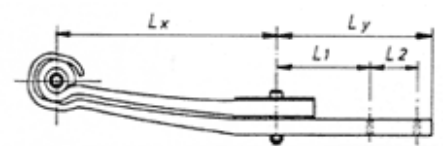

Anh\_50\_5

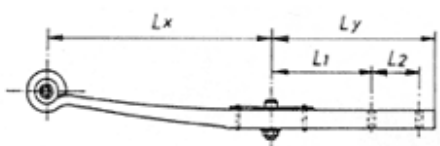

Anh\_50\_6

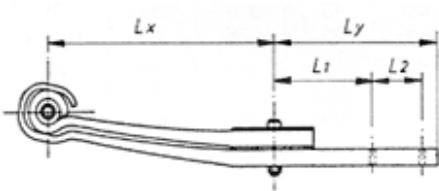

Anh\_52b



Anh\_53a



Anh\_53b



Anh\_54a



Anh\_54b



Anh\_55a



Anh\_56



Anh\_56



Anh\_56\_2

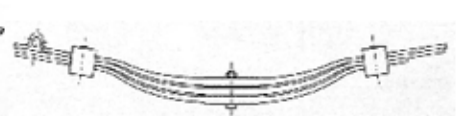

Anh\_57\_1



Anh\_57\_8

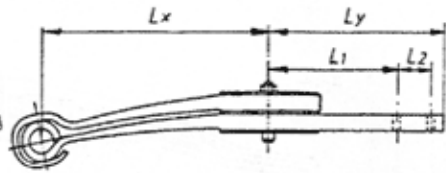

Anh\_58a1

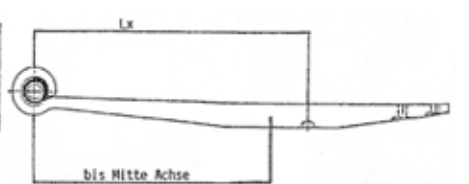

Anh\_58a2

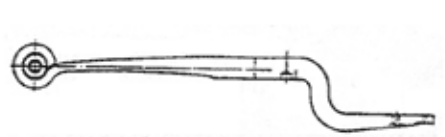

Anh\_58a3

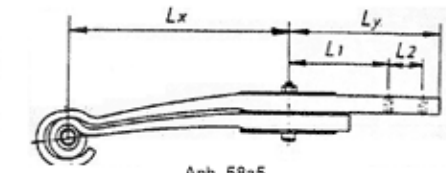

Anh\_58a5



Anh\_59



Anh\_6



Anh\_62a

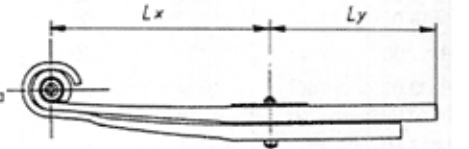

Anh\_63b



Anh\_64

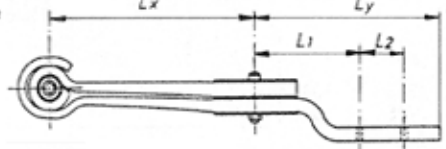

Anh\_66\_5

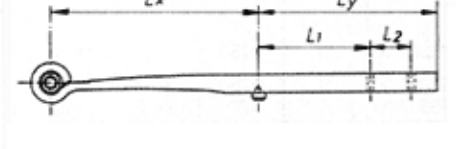

Anh\_66\_6



Anh\_67\_2

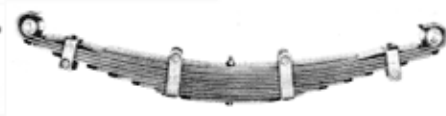

Anh\_67\_3



Anh\_70a



Anh\_70b

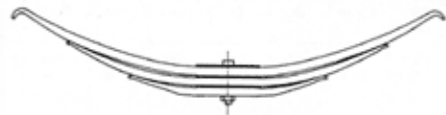

Anh\_7b

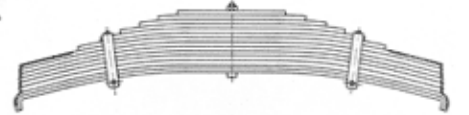

Anh\_9